

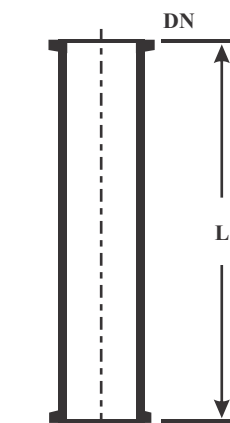

Borolab
Scientific Glass Pvt. Ltd.

PIPE SECTIONS

DN	25	40	50
L	Cat. Ref.	Cat Ref.	Cat. Ref.
100	BPS1/100	BPS1.5/100	BPS2/100
150	BPS1/150	BPS1.5/150	BPS2/150
200	BPS1/200	BPS1.5/200	BPS2/200
250	BPS1/250	BPS1.5/250	BPS2/250
300	BPS1/300	BPS1.5/300	BPS2/300
400	BPS1/400	BPS1.5/400	BPS2/400
500	BPS1/500	BPS1.5/500	BPS2/500
600	BPS1/600	BPS1.5/600	BPS2/600
750	BPS1/750	BPS1.5/750	BPS2/750
900	BPS1/900	BPS1.5/900	BPS2/900



DN	80	100	150
L	Cat. Ref.	Cat Ref.	Cat. Ref.
100	BPS3/100	BPS4/100	BPS6/100
150	BPS3/150	BPS4/150	BPS6/150
200	BPS3/200	BPS4/200	BPS6/200
300	BPS3/300	BPS4/300	BPS6/300
400	BPS3/400	BPS4/400	BPS6/400
500	BPS3/500	BPS4/500	BPS6/500
600	BPS3/600	BPS4/600	BPS6/600
750	BPS3/750	BPS4/750	BPS6/750
900	BPS3/900	BPS4/900	BPS6/900
1000	BPS3/1000	BPS4/1000	BPS6/1000

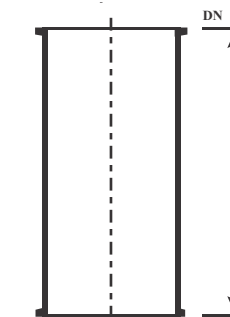

DN	400	450	600/800
L	Cat. Ref.	Cat. Ref.	Cat. Ref.
300	BPS16/300	BPS18/300	BPS32/500
500	BPS16/500	BPS18/500	BPS24/500
750	BPS16/750	BPS18/750	BPS32/1000
1000	BPS16/1000	BPS18/1000	BPS24/1000
1200	BPS16/1200	BPS18/1500	BPS32/1500
1500	BPS16/1200	BPS18/1500	BPS24/1500

SPACERS

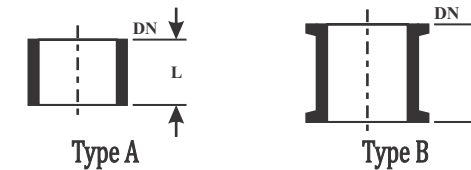

DN	Type	25	40	50
L	Cat. Ref.	Cat Ref.	Cat. Ref.	Cat. Ref.
5	A	BSS1/5	BSS1.5/5	BSS2/5
15	A	BSS1/15	BSS1.5/15	BSS2/15
25	A	BSS1/25	BSS1.5/25	BSS2/25
50	B	BSS1/50	BSS1.5/50	BSS2/50

PTFE SPACERS

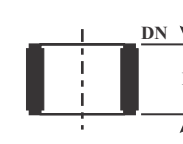

DN	25	40	50
L	Cat. Ref.	Cat Ref.	Cat. Ref.
5	BSST1/5	BSST1.5/5	BSST2/5
10	BSST1/10	BSST1.5/10	BSST2/10
15	BSST1/15	BSST1.5/15	BSST2/15
20	BSST1/20	BSST1.5/20	BSST2/20

EQUAL TEES

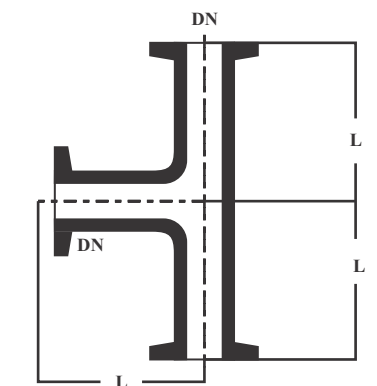

Cat. Ref.	DN	L
BPT1	25	100
BPT1.5	40	150
BPT2	50	150
BPT3	803	200
BPT4	100	250
BPT6	150	250
BPT9	225	375
BPT12	300	450

UNEQUAL TEES

Cat. Ref.	DN	DN1	L	L1
BPTU1.5/1	40	25	200	75
BPTU2/1	50	25	200	80
BPTU2/1.5	50	40	200	100
BPTU3/1	80	25	250	100
BPTU3/1.5	80	40	250	100
BPTU3/2	80	50	250	115
BPTU4/1	100	25	250	110
BPTU4/1.5	100	40	250	125
BPTU4/2	100	50	250	125
BPTU4/3	100	80	300	150
BPTU6/1	150	25	250	150
BPTU6/1.5	150	40	250	150
BPTU6/2/1	50	50	250	150
BPTU6/3	150	80	300	175
BPTU6/4	150	100	300	200
BPTU9/1	225	25	300	185
BPTU9/1.5	225	40	300	185
BPTU9/2	225	50	300	185
BPTU9/3	225	80	300	210
BPTU9/4	225	100	450	250
BPTU9/6	225	150	450	275
BPTU12/1	300	25	400	230
BPTU12/1.5	300	40	400	230

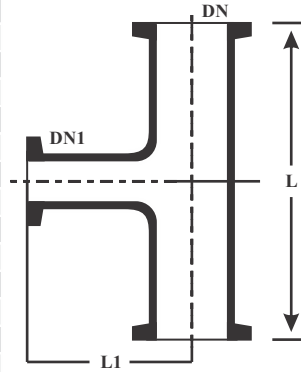

DN	DN1	L	L1	Cat. Ref.
300	50	400	230	BPTU12/2
300	80	400	275	BPTU12/3
300	100	400	275	BPTU12/4
300	150	450	300	BPTU12/6
300	225	600	300	BPTU12/9
400	40	400	275	BPTU16/1.5
400	50	400	275	BPTU16/2
400	80	400	300	BPTU16/3
400	100	400	300	BPTU16/4
400	150	500	350	BPTU16/6
400	225	800	450	BPTU16/9
400	300	800	450	BPTU16/12
450	40	400	300	BPTU18/1.5
450	50	400	300	BPTU18/2
450	80	400	320	BPTU18/3
450	100	400	320	BPTU18/4
450	150	600	380	BPTU18/6
450	225	800	400	BPTU18/9
450	300	800	400	BPTU18/12
600	100	600	450	BPTU24/4
600	150	600	450	BPTU24/6
600	225	800	525	BPTU24/9
600	300	800	525	BPTU24/12

REDUCERS

DN	DN1	L	Cat. Ref.
40	25	100	BPR1.5/1
50	25	100	BPR2/1
50	40	100	BPR2/1.5
80	25	125	BPR3/1
80	40	125	BPR3/1.5
80	50	125	BPR3/2
100	25	150	BPR4/1
100	40	150	BPR4/1.5
100	50	150	BPR4/2
100	80	150	BPR4/3
150	25	200	BPR6/1
150	40	200	BPR6/1.5
150	50	200	BPR6/2
150	80	200	BPR6/3
150	100	200	BPR6/4
225	25	250	BPR9/1
225	40	250	BPR9/1.5
225	50	250	BPR9/2
225	80	250	BPR9/3
225	100	250	BPR9/4
225	150	250	BPR9/6

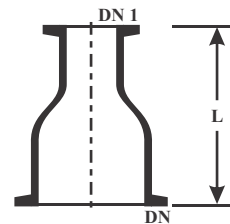

DN	DN1	L	Cat. Ref.
300	25	300	BPR12/1
300	40	300	BPR12/1.5
300	50	300	BPR12/2
300	80	300	BPR12/3
300	100	300	BPR12/4
300	150	300	BPR12/6
300	225	300	BPR12/9
400	40	350	BPR16/1.5
400	50	350	BPR16/2
400	80	350	BPR16/3
400	100	350	BPR16/4
400	150	350	BPR16/6
400	225	350	BPR16/9
400	300	350	BPR16/12
450	40	375	BPR18/1.5
450	50	375	BPR18/2
450	80	375	BPR18/3
450	100	375	BPR18/4
450	150	375	BPR18/6
450	225	375	BPR18/9
450	300	375	BPR18/12
600	100	400	BPR24/4
600	150	400	BPR24/6
600	225	425	BPR24/9
600	300	425	BPR24/12

BENDS 90°

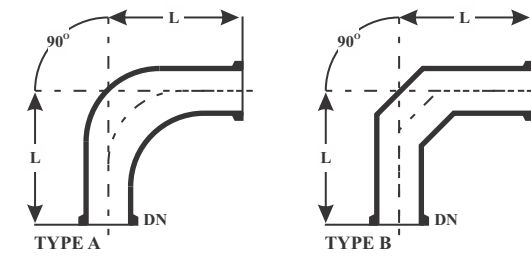

Cat. Ref.	DN	L	Type
BPB1/90	25	100	A
BPB1.5/90	40	150	A
BPB2/90	50	150	A
BPB3/90	80	200	B
BPB4/90	100	250	B
BPB6/90	150	250	B
BPB9/90	225	375	B
BPB12/90	300	450	B

Bends in 80 and 100 degree are also available with same dimensions.
Bends DN 400 / DN 450 / DN600 on request basis.

U BENDS

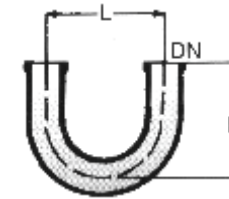

Cat. Ref.	DN	L
BPU1	25	150
BPU1.5	40	175
BPU2	50	175
BPU3	80	225

90° BENDS WITH THERMOMETER POCKET

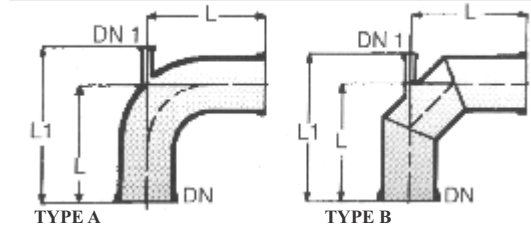

Cat. Ref.	DN	DN1	L	L1	Type
BPBT1.5	40	25	150	225	A
BPBT2	50	25	150	225	A
BPBT3	80	25	200	275	B
BPBT4	100	25	250	350	B
BPBT6	150	25	250	375	B
BPBT9	225	25	375	525	B
BPBT12	300	25	450	550	B

BENDS 45°

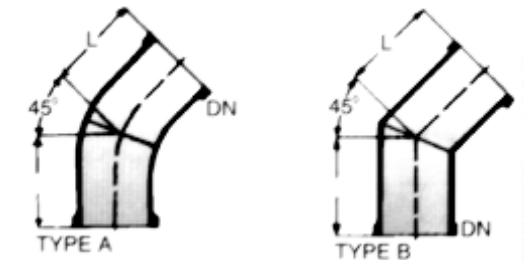

Cat. Ref.	DN	L	Type
BPB1/45	25	75	A
BPB1.5/45	40	100	A
BPB2/45	50	100	A
BPB3/45	80	125	B
BPB4/45	100	175	B

Bends in 10 and 30 degree are also available with same dimensions.

Y BENDS

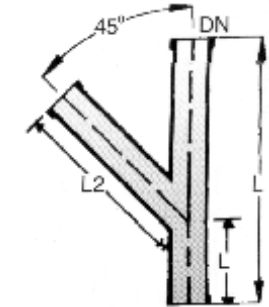

Cat. Ref.	DN	L	L1	L2
BPY1	25	200	75	150
BPY1.5	40	250	100	175
BPY2	50	300	125	200
BPY3	80	350	150	250
BPY4	100	450	150	350

BOTTOM OUTLET UBENDS

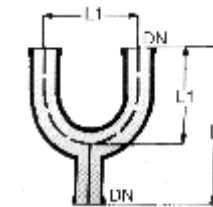

DN	DN1	L	L1	Cat. Ref.
25	25	250	150	BPUO1
40	40	275	175	BPUO1.5
40	25	275	175	BPUO1.5/1
50	50	275	175	BPUO2
50	25	275	175	BPUO2/1
80	25	350	225	BPUO3/1

CROSSES

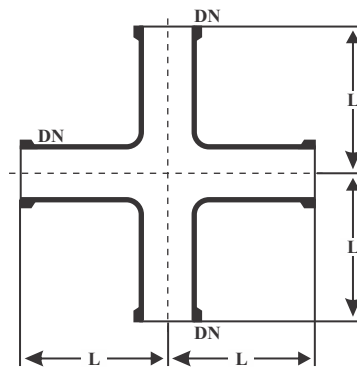

Cat. Ref.	DN	L
BPX1	25	100
BPX1.5	40	150
BPX2	50	150
BPX3	80	200
BPX4	100	250

BLINDS

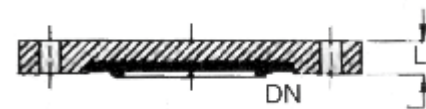

Cat. Ref.	DN	L
BPBF1	25	8
BPBF1.5	40	8
BPBF2	50	8
BPBF3	80	8
BPBF4	100	8
BPBF6	150	9
BPBF9	225	9
BPBF12	300	9

CLOSURES

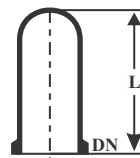

Cat. Ref.	DN	L
BPBE1	25	50
BPBE1.5	40	75
BPBE2	50	75
BPBE3	80	100
BPBE4	100	125
BPBE6	150	125
BPBE9	225	150
BPBE12	300	150

UNEQUAL CROSSES

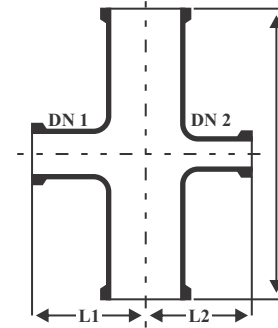

Cat. Ref.	DN	DN1	DN2	L	L1	L2
BPXU2/1/1	50	25	25	200	80	80
BPXU2/1.5/1	50	40	25	200	100	80
BPXU3/1/1	80	25	25	250	100	100
BPXU3/1.5/1	80	40	25	250	100	100
BPXU3/2/1	80	40	25	250	115	100
BPXU4/1/1	100	25	25	250	110	110
BPXU4/1.5/1	100	40	25	250	125	110
BPXU6/3/2	100	50	25	250	125	110
BPTU4/3/1	100	80	25	300	150	150
BPXU6/1.5/1	150	40	25	250	150	150
BPXU6/2/1	150	50	25	250	150	150
BPXU6/3/2	150	80	50	300	175	150
BPXU6/4/2	150	100	50	300	200	150
BPXU9/1.5/1.5	225	40	40	300	185	185
BPXU9/2/1.5	225	50	40	300	185	185
BPXU9/3/1.5	225	80	40	300	210	185
BPXU9/4/2	225	100	50	450	250	185
BPXU9/6/3	225	150	80	450	275	210
BPXU12/2/1.5	300	50	40	400	230	230
BPXU12/3/1.5	300	80	40	400	275	230
BPXU12/4/1.5	300	100	40	400	275	230
BPXU12/6/2	300	150	50	450	300	230
BPXU12/9/3	300	225	80	600	300	275
BPXU16/1.5/1.5	400	40	40	400	275	275
BPXU16/3/1.5	400	80	40	400	300	275
BPXU16/4/1.5	400	100	40	400	300	275
BPXU16/6/3	400	150	80	500	350	300
BPXU16/9/4	400	225	100	800	450	300
BPXU18/1.5/1.5	450	40	40	400	300	300
BPXU18/3/1.5	450	80	40	400	320	300
BPXU18/4/1.5	450	100	40	400	320	300
BPXU18/6/3	450	150	80	600	380	320

JACKETTED PIPE SECTION

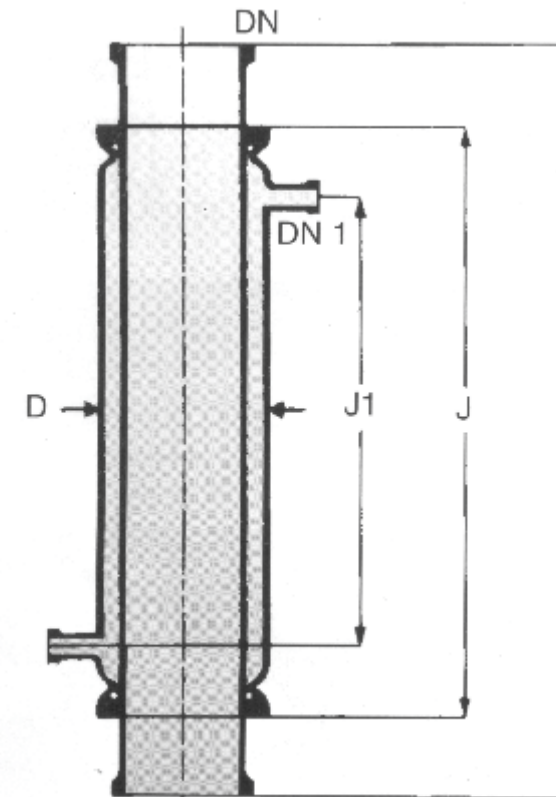

Glass Jackets

For heating of piping and for controlling the temperature throughout the column, the jacketted pipe section using Viton "O" ring and other sealing composition. The seal prevents impermissibly high stresses between two tubes and allows the movement which comes due to thermal expansion. Maximum operating pressure in the jacket :

- (1) DN 80 - DN 150 1.0 bar
- (2) DN 225 - DN 300 0.5 bar

Cat. Ref.	DN	L	d	DN1	J	J1
BPSD3/1000	80	1000	100	25	850	750
BPSD4/1000	100	1000	150	25	850	750
BPSD6/1000	150	1000	225	25	850	700
BPSD9/1000	225	1000	300	25	850	700
BPSD12/1000	300	1000	400	25	850	650

Metal Jackets

Pipe sections can also be provided with metal jackets. In metal jackets, maximum operating pressure permitted is 2.0 bar in all the sizes.

Cat. Ref.	DN	L	d	DN1	J	J1
BPSJ3/1000	80	1000	100	25	850	750
BPSJ4/1000	100	1000	135	25	850	750
BPSJ6/1000	150	1000	188	25	850	700
BPSJ9/1000	225	1000	262	25	850	700
BPSJ12/1000	300	1000	345	25	850	650

HOSE CONNECTORS

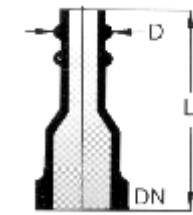

Cat. Ref.	DN	d	L
BPHC1/1	25	28	90
BPHC1/.75	25	22	90
BPHC1/5	25	15	90
BPHC1/.25	25	11	90
BPHC1.5/1	40	28	100
BPHC1.5/.75	40	22	100

BEND HOSE CONNECTORS

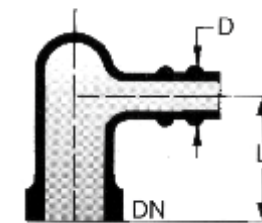

Cat. Ref.	DN	d	L
BPBHC1/1	25	28	60
BPBHC1/.75	25	22	60
BPBHC1.5/.75	40	22	75
BPBHC2/.75	50	22	100

ADAPTER PLATE FOR REACTORS

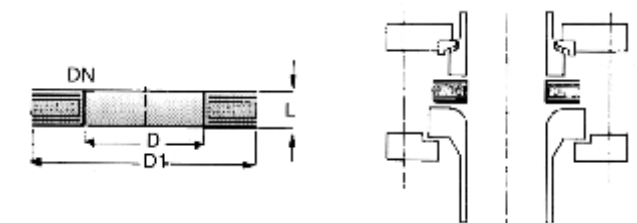

When reactors have a curved end nozzle, these adaptors are used as interface spacer to connect the glass/below with reactor. A flat metal ring with rubber cushions is enveloped with PTFE, to provide ideal sealing. Only PTFE comes in the contact of process fluid.